

ITEM	COMPONENT NAME	MATERIAL	COMPONENT PN	QTY
1	NIPPLE	NICKEL 200	NIP-60NI-6TS-30F	1
2	NUT	303 SST	NUT-660SS	1
3	GASKET	PCTFE	GSK-60-K	1

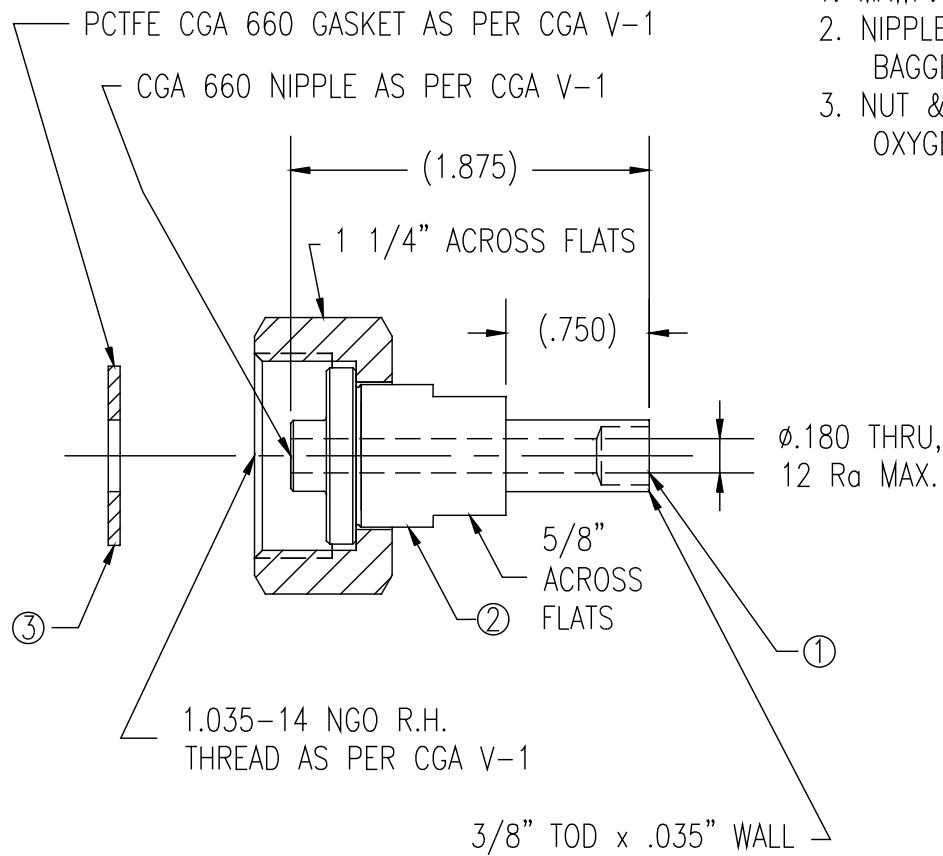

NOTES:

1. MAWP: 3000 PSI
2. NIPPLE IS ULTRASONICALLY D.I. CLEANED AND SINGLE BAGGED.
3. NUT & GASKET ARE CLEANED FOR OXYGEN SERVICE AND SINGLE BAGGED.

UNCONTROLLED
For Reference Only

MB 4/24/2013

GasFlo Products Inc.
Fairfield, N.J.

SALES DWG.- INLET CGA 660 x 3/8 TUBE STUB
1.875" NI

THIS DOCUMENT CONTAINS INFORMATION THAT IS THE PROPRIETARY AND CONFIDENTIAL PROPERTY OF GASFLO PRODUCTS INC. AND MAY BE USED ONLY FOR AUTHORIZED PURPOSES. THIS DOCUMENT MAY NOT BE REPRODUCED WITHOUT GASFLO PRODUCTS INC. PRIOR WRITTEN CONSENT.

DWN: MB

SCALE: NTS

APPVD:

DATE: 4/24/13

DWG: SALES-INL-660NI-6TS-30F